

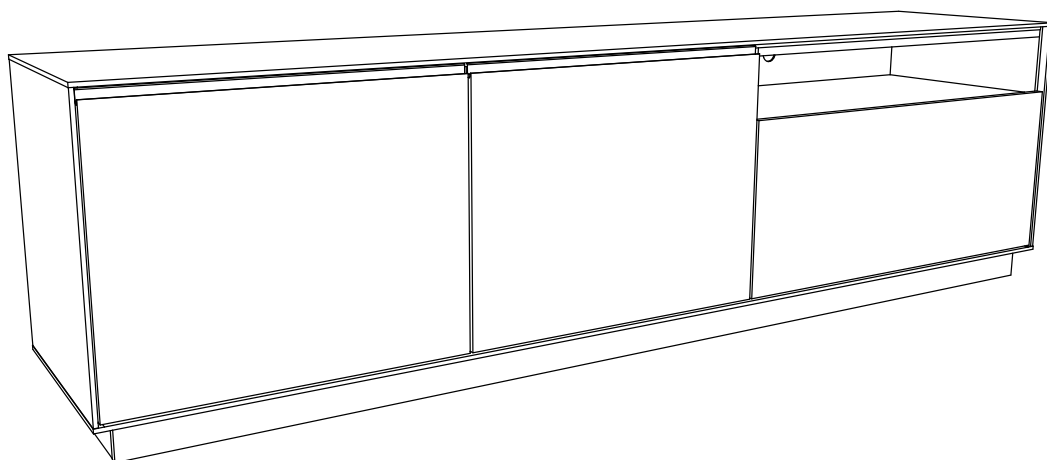

PRODUTO CONCLUÍDO  
PRODUCTO TERMINADO  
FINISHED PRODUCT

ITM/S313-  
REV. 000



**HENN**

Ind. e Com. de Móveis Henn  
Mondaí - SC - Brasil

+55 49 3674.3500

@moveishenn  
www.henn.com.br

ITM/S313-

**INSTRUÇÕES DE  
MONTAGEM**

INSTRUCCIONES DE MONTAJE  
ASSEMBLY INSTRUCTIONS

RACK AURYN 3 PORTAS | RACK AURYN 3 PUERTAS | AURYN RACK 3 DOORS

S313-225 Off White/Cinamomo

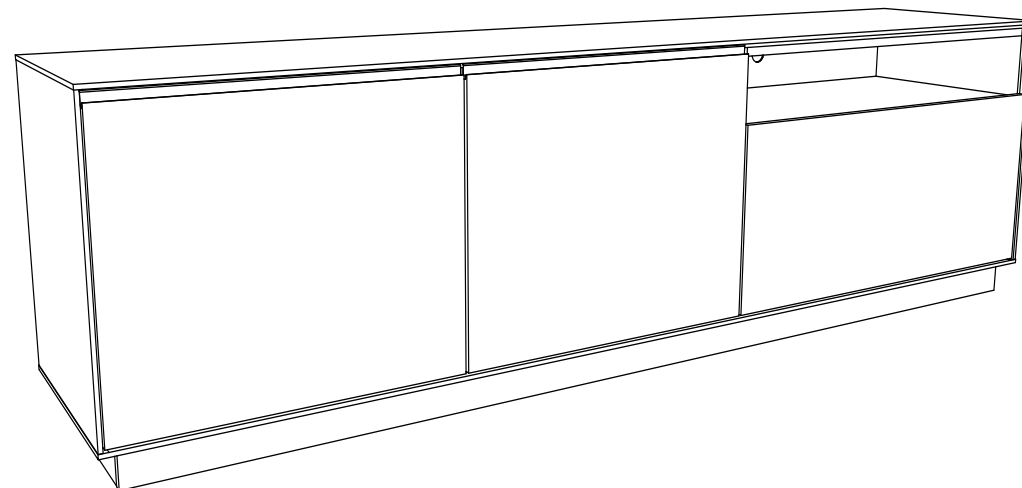

**AVISO**

Para limpeza de seu móvel, use uma flanela seca ou umedecida, e não utilize produtos químicos que possam danificar seu produto.

**SISTEMA DE MONTAGEM**

O sistema de montagem dos produtos, funciona de acordo com a ordem crescente dos números indicados no desenho. Ex: 01, 02, 03, 04... até a conclusão da montagem.

**ASSISTÊNCIA TÉCNICA**

Para solicitação de Assistência Técnica você consumidor deverá entrar em contato com o Lojista o qual você realizou a compra deste produto e solicitar a assistência técnica das peças avariadas. A garantia abrange todas as peças, partes e componentes que eventualmente venham apresentar defeito de fabricação no prazo de 03 (três) meses, contando a partir da entrega do produto ao consumidor, mediante nota fiscal de compra. Se houver qualquer alteração na estrutura do produto ou ocorrer defeito por negligência do montador/consumidor em relação a instrução de montagem e manuseio, não será fornecido assistência técnica gratuita.

**ADVERTENCIA**

Para limpieza de su móvil, use una franela seca o húmeda, y no utilice productos químicos que puedan dañar su producto.

**SISTEMA DE MONTAJE**

El sistema de montaje de los productos funciona de acuerdo con el orden creciente de los números indicados en el dibujo. Ej.: 01, 02, 03, 04... hasta la conclusión del montaje.

**ASISTENCIA TÉCNICA**

Para solicitar Asistencia Técnica, el consumidor debe comunicarse con el Comercio que usted realizó la compra de este producto y solicita asistencia técnica para las partes dañadas. La garantía cubre todas las partes, piezas y componentes que eventualmente puedan presentar defecto de fabricación en el plazo de 03 (tres) meses, contados a partir de la entrega del producto al consumidor, mediante factura de compra. Si se produce algún cambio en la estructura del producto o se produce un defecto por negligencia del montador/consumidor en relación con las instrucciones de montaje y manipulación, no se prestará asistencia técnica gratuita.

**NOTICE**

To clean your furniture, use a dry or wet cloth, and do not use chemicals that may damage your product.











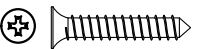

**ASSEMBLY SYSTEM**

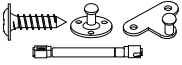
The products' assembly system works according to the increasing order of the indicated numbers. For example: 01, 02, 03, 04 ... to the end of the assembly.

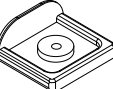
**TECHNICAL ASSISTANCE**

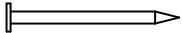
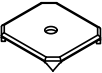
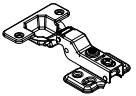
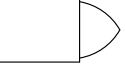
To request Technical Assistance, the consumer must contact the retailer from whom you purchased this product and request technical assistance for the damaged parts. The warranty covers all parts, parts and components that may eventually present a manufacturing defect within a period of 03 (three) months, counting from the delivery of the product to the consumer, by means of a purchase invoice. If there is any change in the structure of the product or defect occurs due to negligence of the assembler/consumer in relation to the assembly and handling instruction, free technical assistance will not be provided.

ACESSÓRIOS | ACCESORIOS | ACCESSORIES



<b>A</b> x24  Parafuso 3,5x40mm CHT.	<b>B</b> x3  Parafuso 4,0x25mm CHT.	<b>C</b> x60  Parafuso 4,0x14mm CHT.	<b>D</b> x4  Parafuso Minifix
<b>E</b> x4  Tambor Minifix	<b>F</b> x34  Cavilha 8x25mm	<b>G</b> x1  Kit Pistão a Gás 80N Força Inversa	<b>H</b> x12  Cantoneira Plástica 20x20mm
<b>I</b> x8  Sapata L 16x20mm	<b>J</b> x8  Prego 12x12mm Anelado	<b>K</b> x74  Prego 10x10mm	<b>L</b> x18  Fixador de Fundo
<b>M</b> x6  Dobradiça 35mm Pop Alta com Armotecedor + Calço Fixo	<b>N</b> x3  Giz de Correção.	<b>O</b> x4  Adesivo Tapa Parafuso 17mm.	<b>P</b> x22  Adesivo Tapa Parafuso 10mm.
<b>Q</b> x1  Sachê de Cola.	<b>R</b> x1  Etiqueta Resinada Henn.		



2 PARAFUSOS EM ESCALA 1:1 | TORNILLOS A ESCALA 1:1 | 1:1 SCALE SCREWS

MONTAGEM 10 | MONTAJE 10 | ASSEMBLY 10

ACESSÓRIOS REQUERIDOS

N		03	P		22
O		04	R	<b>HENN</b>	01

Pesos máximos recomendados com carga distribuída  
Peso máximo recomendado con la carga distribuida  
Recommended maximum weight with distributed load.

**Suporta TV de até 70"**

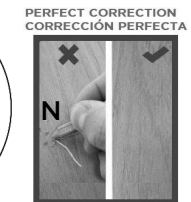
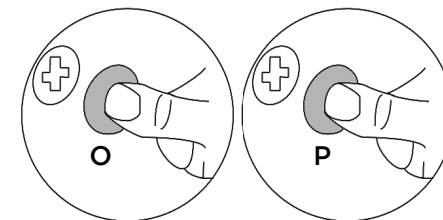
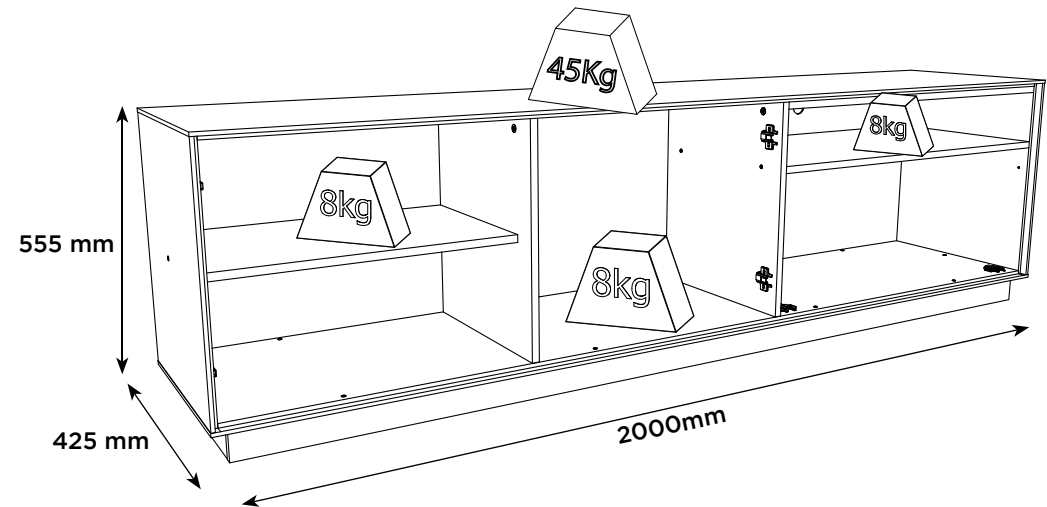

**PEÇAS REQUERIDAS**

17	PORTA ESQUERDA	x1
18	PORTA DIREITA	x1
19	PORTA BASCULANTE	x1

**ACESSÓRIOS REQUERIDOS**

C		24
G		01

**FERRAMENTAS NECESSÁRIAS**

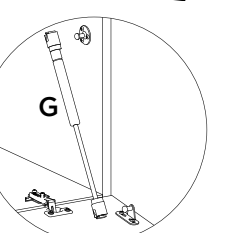
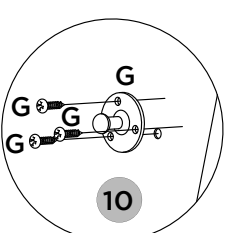
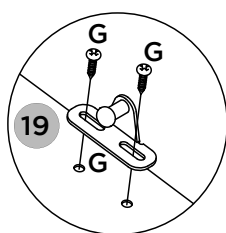
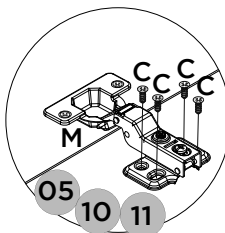
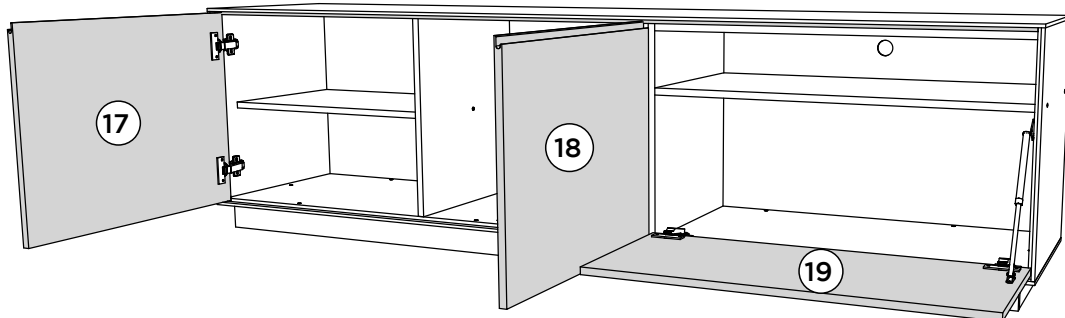
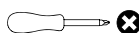

**OPÇÃO DO KIT RODÍZIO (O897-53)**

**VISTA INFERIOR**

Esse Kit Rodízio é opcional e é vendido separadamente.

Este kit de rodízio es opcional y se vende por separado.

This rotation kit is optional and sold separately.

Fixar o Rodízio à 50 mm de distancia dos rodapés

Fijar el rodete a 50 mm de distancia de los zócalos

Attach the Turntable 50 mm away from the baseboards

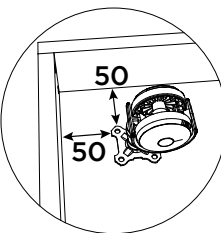

As ferragens necessárias acompanham o Kit Rodízio

Los herrajes necesarios vienen con el Kit de Rodízio

The necessary hardware comes with the Caster Kit

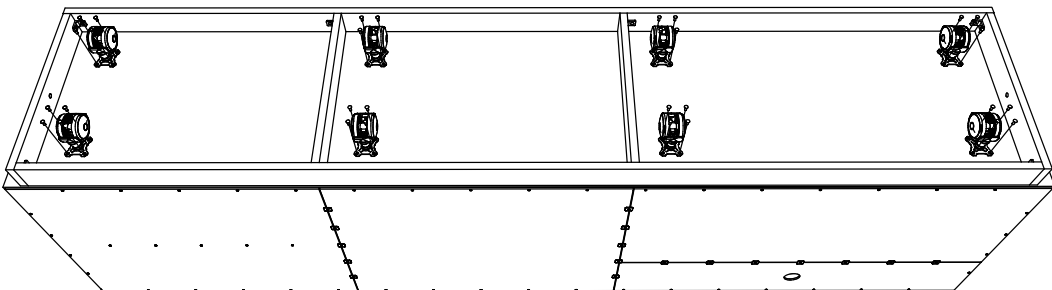

**LISTA DE PEÇAS**

LISTA DE PIEZAS | LIST OF PIECES

Item	Caixa Caja Box	Qty Ctd Qty	Descrição Descripción Description	Dimensões (mm)   Dimensiones (mm)   Dimensions (mm)		
				Comprimento Largo Length	Largura Ancho Width	Espessura Grosor Thickness
1	1/1	1	RODAPÉ FRONTAL   ZÓCALO FRONTAL   FRONT BASEBOARD	1937	60	15
2	1/1	2	TRAVESSA DO RODAPÉ   TRAVESAÑO DE ZÓCALO   BASEBOARD CROSSPIECE	362	60	15
3	1/1	2	RODAPÉ LATERAL   ZÓCALO LATERAL   SIDE BASEBOARD	377	60	15
4	1/1	1	RODAPÉ TRASEIRO   ZÓCALO TRASERO   REAR BASE	1906	60	15
5	1/1	1	LATERAL ESQUERDA   LATERAL IZQUIERDA   LEFT SIDE	476	420	15
6	1/1	1	PRATELEIRA   ESTANTE   SHELF	580	350	15
7	1/1	1	DIVISÃO ESQUERDA   DIVISIÓN IZQUIERDA   LEFT DIVISION	460	403	15
8	1/1	1	DIVISÃO DIREITA   DIVISIÓN DERECHA   RIGHT DIVISION	460	403	15
9	1/1	1	PRATELEIRA EXTERNA   ESTANTE EXTERIOR   EXTERNAL SHELF	780	403	15
10	1/1	1	LATERAL DIREITA   LATERAL DERECHA   RIGHT SIDE	476	420	15
11	1/1	1	BASE   BASE   BASE	2001	421	15
12	1/1	1	TAMPO   TAPA   TOP	2001	421	15
13	1/1	1	TRAVESSA   TRAVESAÑO   CROSSPIECE	780	60	15
14	1/1	1	FUNDO COM FURO   FONDO CON AGUJERO   BACK PANEL WITH HOLE	797	154	3
15	1/1	1	FUNDO   FONDO   BACKGROUND	797	329	3
16	1/1	2	FUNDO MAIOR   FONDO MÁS GRANDE   LARGER BACKGROUND	597	484	3
17	1/1	1	PORTA ESQUERDA   PUERTA IZQUIERDA   LEFT DOOR	590	470	15
18	1/1	1	PORTA DIREITA   PUERTA DERECHA   RIGHT DOOR	590	470	15
19	1/1	1	PORTA BASCULANTE   PUERTA BASCULANTE   TILT DOOR	790	335	15

**VISTA EXPLODIDA DAS PEÇAS** | VISTA DESPIECE DE LAS PIEZAS | EXPLODED VIEW OF THE PARTS.

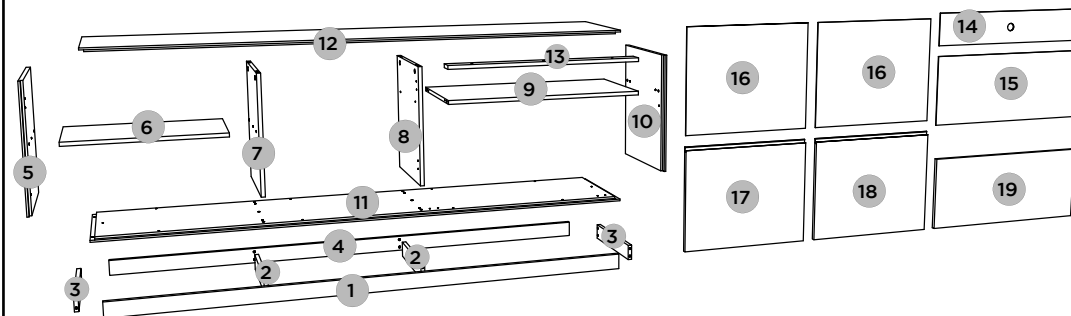

**REQUISITOS PARA MONTAGEM**  
REQUISITOS PARA LA MONTAJE | ASSEMBLY REQUIREMENTS.

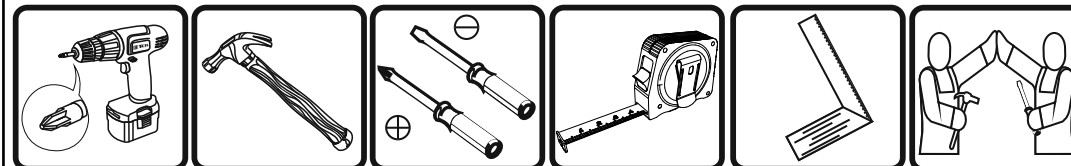

Imagens meramente ilustrativas, não acompanha o produto.  
Imágenes ilustrativas, no incluidas con el producto.  
Illustrative images, not included with the product.

**PRÉ MONTAGEM** | PRE MONTAJE | PRE ASSEMBLY

ITM/S313-

**PEÇAS REQUERIDAS**

2	TRAVESSA DO RODAPÉ	x2
3	RODAPÉ LATERAL	x2
4	RODAPÉ TRASEIRO	x1
12	TAMPO	x1

**ACESSÓRIOS REQUERIDOS**

D		04
F		18
Q		

**FERRAMENTAS NECESSÁRIAS**

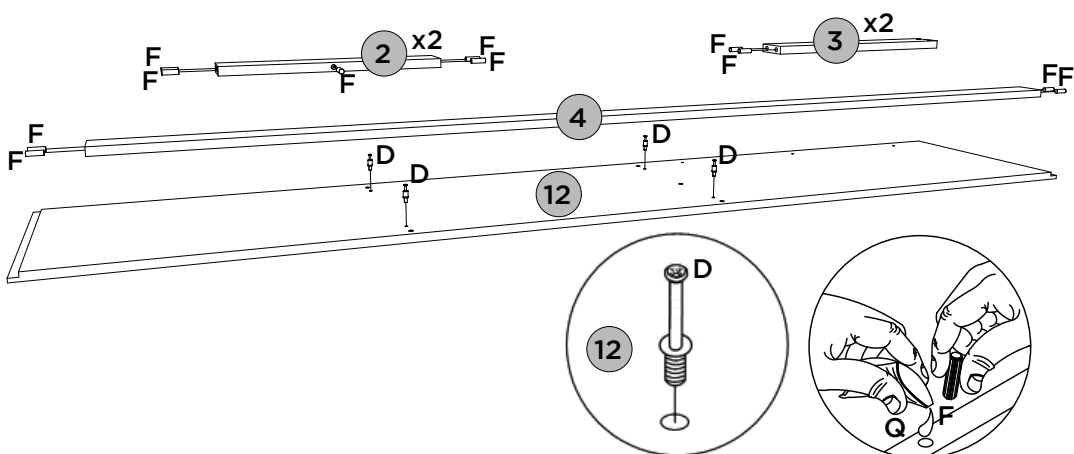
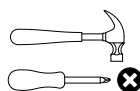

**PRÉ MONTAGEM** | PRE MONTAJE | PRE ASSEMBLY

**PEÇAS REQUERIDAS**

17	PORTA ESQUERDA	x1
18	PORTA DIREITA	x1
19	PORTA BASCULANTE	x1

**ACESSÓRIOS REQUERIDOS**

C		12
M		06

**FERRAMENTAS NECESSÁRIAS**

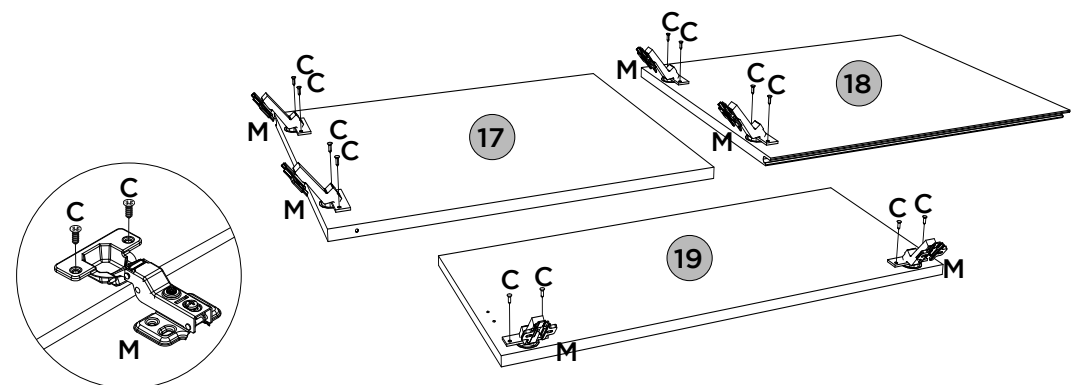
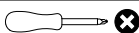

**MONTAGEM 8** | MONTAJE 8 | ASSEMBLY 8

ITM/S313-

**PEÇAS REQUERIDAS**

14	FUNDO COM FURO	x1
15	FUNDO	x1
16	FUNDO MAIOR	x2

**ACESSÓRIOS REQUERIDOS**

K		74
L		18

**FERRAMENTAS NECESSÁRIAS**

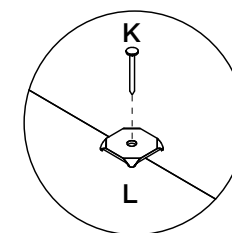
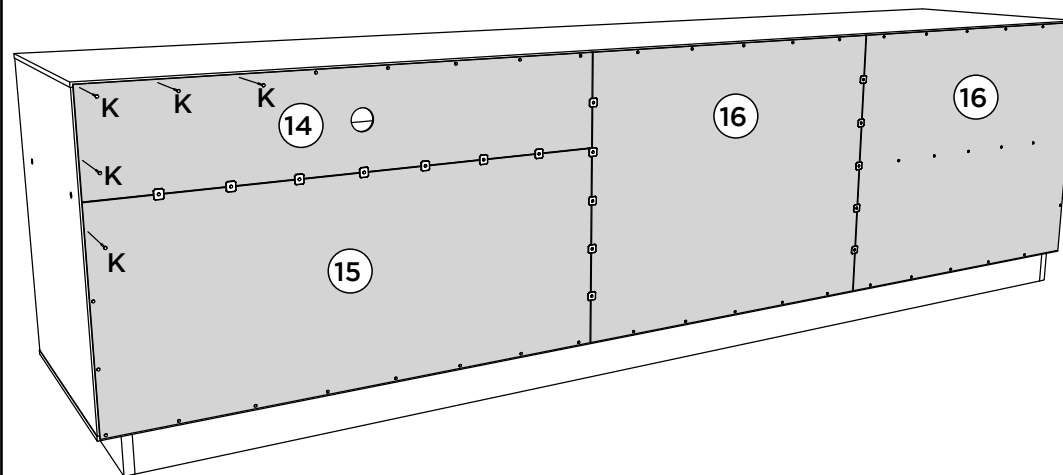

# MONTAGEM 6 | MONTAJE 6 | ASSEMBLY 6

ITM/S313-

## PEÇAS REQUERIDAS

12	TAMPO	x1
13	TRAVESSA	x1

## ACESSÓRIOS REQUERIDOS

B		03
---	--	----

## FERRAMENTAS NECESSÁRIAS

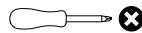

## VISTA INFERIOR

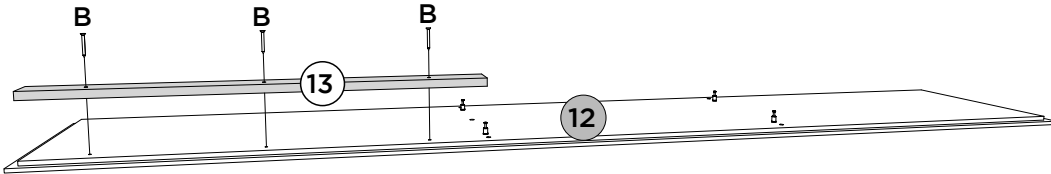

# MONTAGEM 7 | MONTAJE 7 | ASSEMBLY 7

## ACESSÓRIOS REQUERIDOS

C		08
E		04
H		04

## FERRAMENTAS NECESSÁRIAS

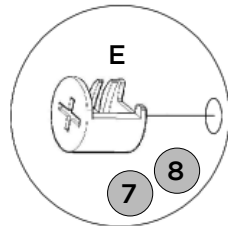
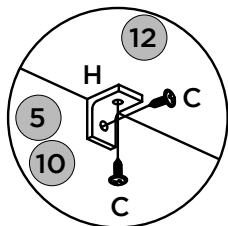
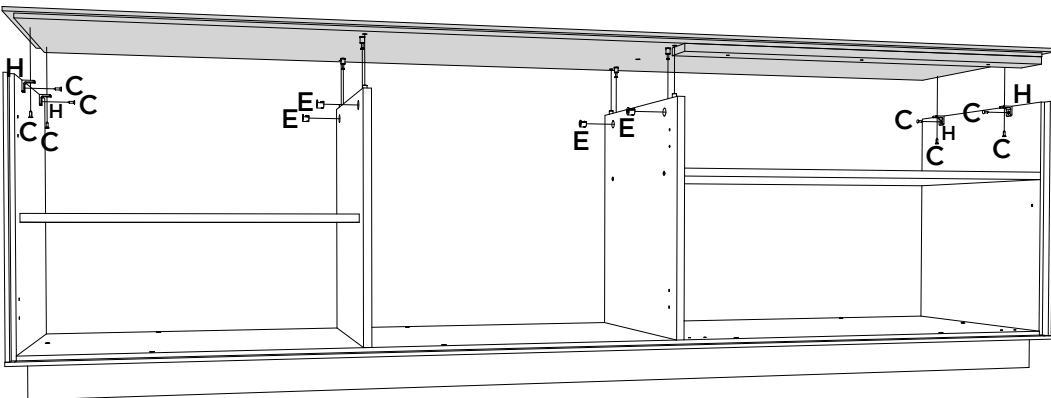
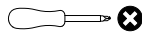

# PRÉ MONTAGEM | PRE MONTAJE | PRE ASSEMBLY

ITM/S313-

## PEÇAS REQUERIDAS

6	PRATELEIRA	x1
7	DIVISÃO ESQUERDA	x1
8	DIVISÃO DIREITA	x1
9	PRATELEIRA EXTERNA	x1

## ACESSÓRIOS REQUERIDOS

F		16
Q		

## FERRAMENTAS NECESSÁRIAS

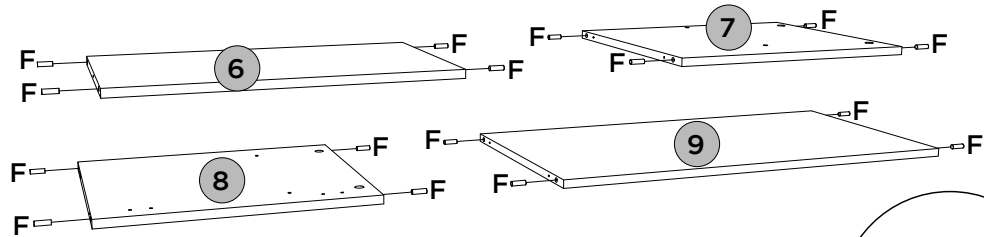
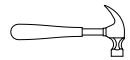

# MONTAGEM 1 | MONTAJE 1 | ASSEMBLY 1

## PEÇAS REQUERIDAS

1	RODAPÉ FRONTAL	x1
2	TRAVESSA DO RODAPÉ	x2
3	RODAPÉ LATERAL	x2
4	RODAPÉ TRASEIRO	x1

## ACESSÓRIOS REQUERIDOS

C		16
H		08
I		08
J		08

## FERRAMENTAS NECESSÁRIAS

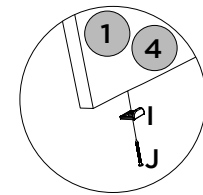
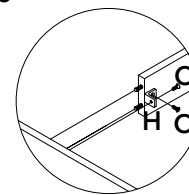
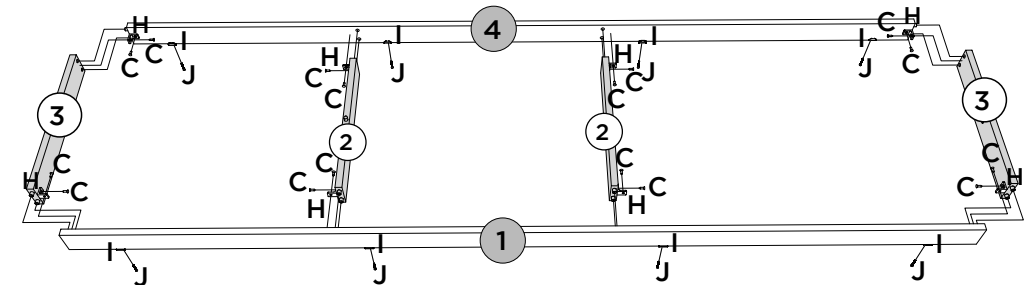
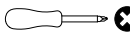

## MONTAGEM 2 | MONTAJE 2 | ASSEMBLY 2

ITM/S313-

### PEÇAS REQUERIDAS

5	LATERAL ESQUERDA	x1
6	PRATELEIRA	x1
7	DIVISÃO ESQUERDA	x1

### ACESSÓRIOS REQUERIDOS



### FERRAMENTAS NECESSÁRIAS

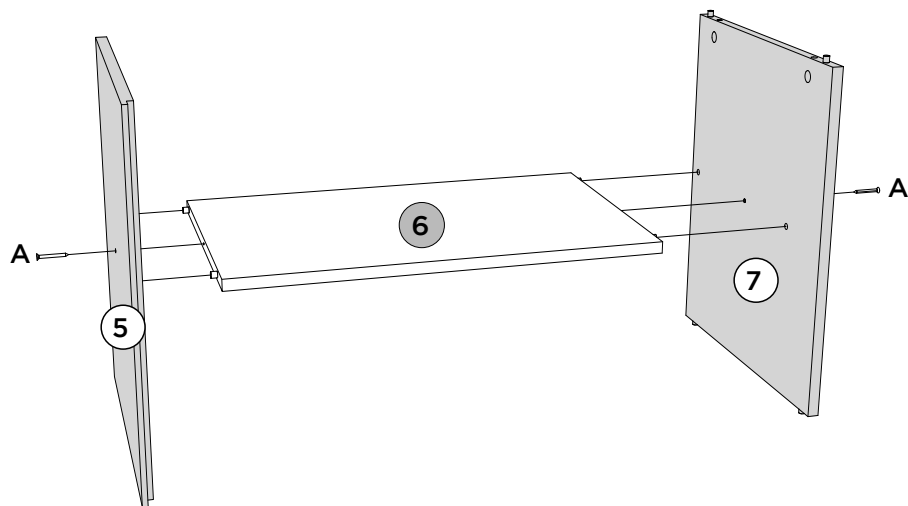
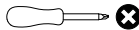

## MONTAGEM 3 | MONTAJE 3 | ASSEMBLY 3

### PEÇAS REQUERIDAS

8	DIVISÃO DIREITA	x1
9	PRATELEIRA EXTERNA	x1
10	LATERAL DIREITA	x1

### ACESSÓRIOS REQUERIDOS

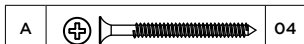

### FERRAMENTAS NECESSÁRIAS

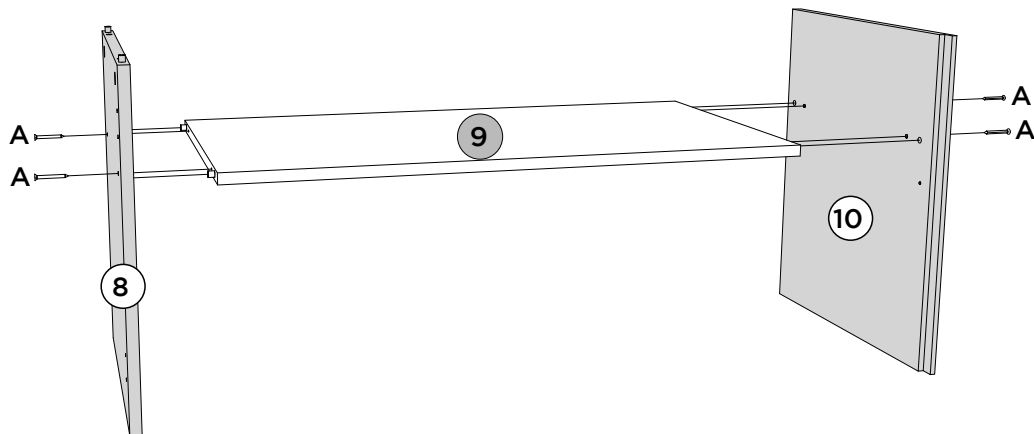
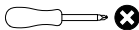

## MONTAGEM 4 | MONTAJE 4 | ASSEMBLY 4

ITM/S313-

### PEÇAS REQUERIDAS

11	BASE	x1
----	------	----

### ACESSÓRIOS REQUERIDOS

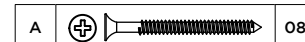

### FERRAMENTAS NECESSÁRIAS

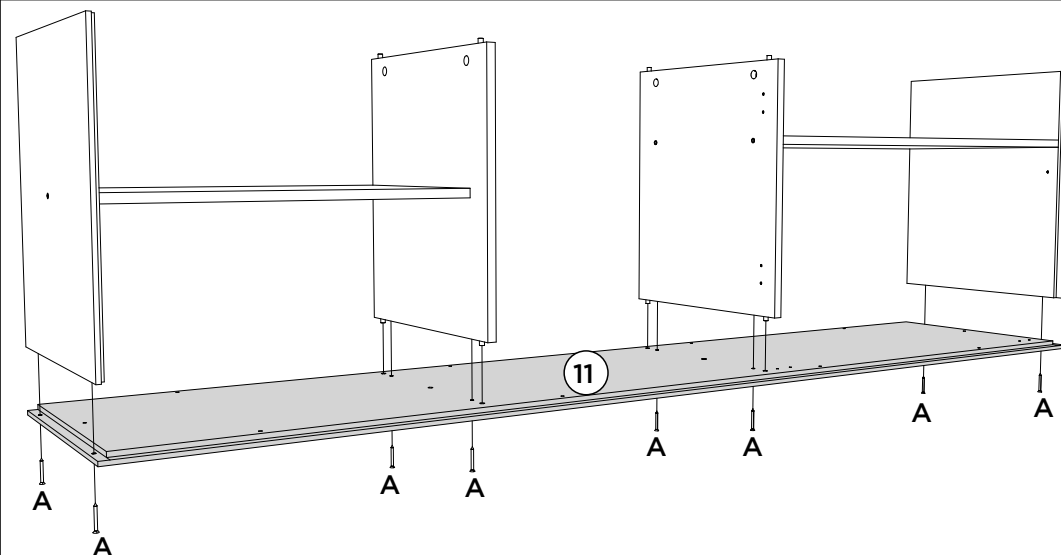

## MONTAGEM 5 | MONTAJE 5 | ASSEMBLY 5

### ACESSÓRIOS REQUERIDOS

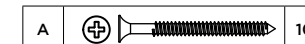

### FERRAMENTAS NECESSÁRIAS

